



COLOUR TELEVISION

INSTRUCTIONS

Thank you for buying this JVC colour television.
To make sure you understand how to use your new TV, please read this manual thoroughly before you begin.

S series:

- AV-21VS21
- AV-21WS21
- AV-25VS21
- AV-29VS21
- AV-29WS21

X series:

- AV-21VX71
- AV-21WX11
- AV-21YX11
- AV-25VX71
- AV-29VX71
- AV-29WX11



GGT0012-001A-H
0403-NIC-JMT

Contents

Safety precautions	2
Preparation	2
1 Insert the batteries into the remote control ..	2
2 Connecting the aerial and VCR	3
3 Connecting other devices	4
4 Connect the power cord to the AC outlet	4
5 SETUP TOUR	5
Basic operation	6
Remote control buttons and functions	7
MUTING button	8
PICTURE BOOSTER button	8
COLOUR SYSTEM button	8
SOUND SYSTEM button	8
CINEMA SURROUND button	8
DISPLAY button	9
ECO SENSOR button	9
⊙○/II button	9
OFF TIMER button	9
PICTURE MODE button	10
CHANNEL SCAN button	10
FAVORITE CH button	10
RETURN + button	10
PIP buttons	11
Viewing Teletext programmes	13
Using the TV's menus	15
Basic operation	15
INPUT	16
PICTURE TILT	16
VNR	16
COMPRESS (16:9)	16
AUTO SHUTOFF	17
CHILD LOCK	17
BLUE BACK	17
VIDEO-2 SET	18
Picture Adjustments	18
Sound Adjustments	18
AI VOLUME	19
AUTO CH PRESET	19
MANUAL CH PRESET	20
SKIP	21
LANGUAGE	21
TEXT LANGUAGE	21
FAVORITE CH SETTING	22
VIDEO SETTING	22
AI ECO SENSOR	23
AI ECO DISPLAY	23
PIP	23
TV buttons and parts	24
Using the buttons on the TV	25
Troubleshooting	26
Specifications	27

Safety precautions

WARNING

TO PREVENT FIRE OR SHOCK HAZARD, DO NOT EXPOSE THIS APPLIANCE TO RAIN OR MOISTURE.

CAUTION

TO ENSURE PERSONAL SAFETY, OBSERVE THE FOLLOWING RULES REGARDING THE USE OF THIS TV.

- Operate only from the power source specified on the TV.
- Avoid damaging the power cord and main plug. When you unplug the TV, pull it out by the main plug. Do not pull on the power cord.
- Never block or cover the cabinet opening for ventilation. Never install the TV where good ventilation is unattainable. When installing this TV, leave spaces for ventilation around the TV more than the minimum distances shown in the diagram.
- Do not allow objects or liquid into the cabinet openings.
- In the event of a fault, unplug the TV and bring to JVC service centre. Do not attempt to repair it by yourself or remove the rear cover.
- The surface of the TV screen is easily damaged. Be very careful with it when handling the TV. Should the TV screen become soiled, wipe it with a soft dry cloth. Never rub it forcefully. Never use any cleaner or detergent on it.
- When you don't use this TV for a long period of time, be sure to disconnect the power plug from the AC outlet.
- The apparatus shall not be exposed to dripping or splashing and that no objects filled with liquids, such as vases, shall be placed on the apparatus.

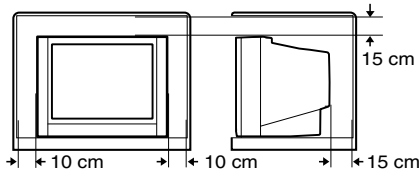

WARNING

< AV-21WS21/AV-21WX11 only >

A removable plastic cover is fixed to the television's front Audio/Video connector. To prevent this cover from being accidentally swallowed by babies or children, remove it from the television and store it in a safe place. If the cover is swallowed seek the advice of a doctor immediately.

Preparation

1 Insert the batteries into the remote control

Correctly insert two batteries, observing the ⊕ and ⊖ polarities and inserting the ⊖ end first.

CAUTION:

Follow the cautions printed on the batteries.

Notes:

- Use AA/R6/UM-3 dry cell batteries.
- If the remote control does not work properly, fit new batteries.
The supplied batteries are for testing, not regular use.

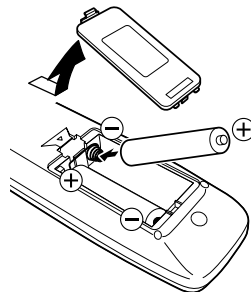

Preparation

2 Connecting the aerial and VCR

- Read the manuals provided with the devices. Depending on the device, the connection method may be different from the diagrams. Also the device settings may need to change depending on the connection method.
- Turn off all the devices including the TV.
- Connecting cables are not supplied.
- When connecting monaural audio to the TV, use the L/MONO jack.
- You can connect an S-VIDEO compatible device (such as an S-VHS VCR) to the S-connector with an S-VIDEO cable and enjoy the high quality picture of the S-VIDEO signal (Y/C signal). In that case, do not connect it to the TV with a video cable.
- If you connect the VCR to the TV only with an aerial cable, you should preset the video channel from the VCR to the AV channel (channel number 0) on this TV. See “MANUAL CH PRESET” on page 20 and preset it manually.

Connecting the aerial

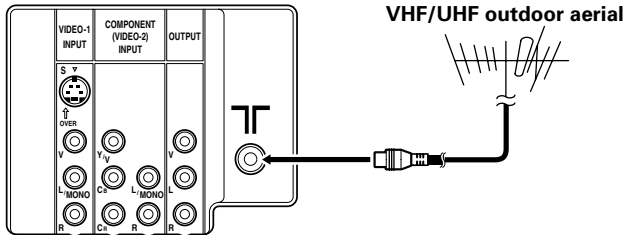

Connecting the aerial and VCR

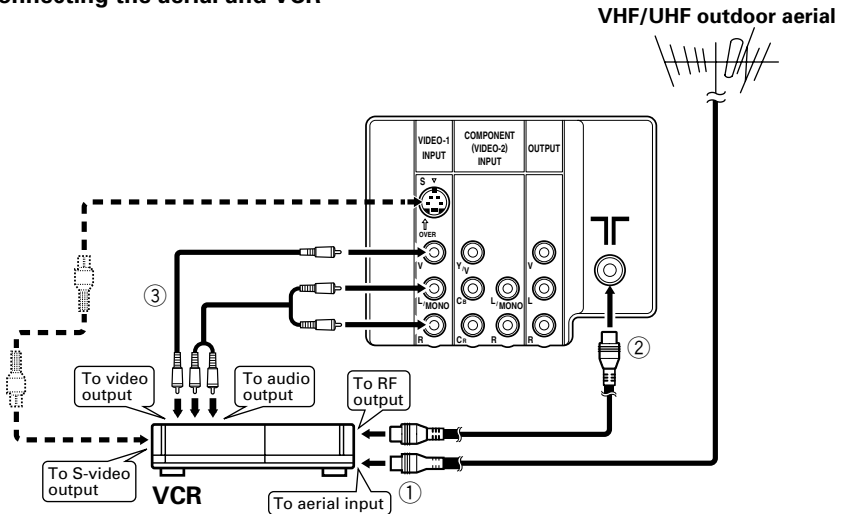

Preparation

3 Connecting other devices

If you are not connecting any other devices, skip step 3 and perform step 4.

- Use the headphones with a stereo mini jack (3.5 mm in diameter). When you connect the headphones, the TV speakers go off.
- The OUTPUT terminal outputs the video and sound signals which you are viewing on the TV. You can dub them onto the VCR connected to the OUTPUT terminal.
(The OUTPUT terminal cannot output S-VIDEO signals or component video signals. Also it cannot output any signals when the TV is turned off.)
- Connect components outputting a component signal (Y/C_B/C_R signal), such as a DVD player, to the VIDEO-2 terminal, and set VIDEO-2 SET function to “COMPONENT”. (See page 18.)
- The following illustrations are for the AV-21VX71. Your TV's front and rear panels may not look exactly like the illustrations.

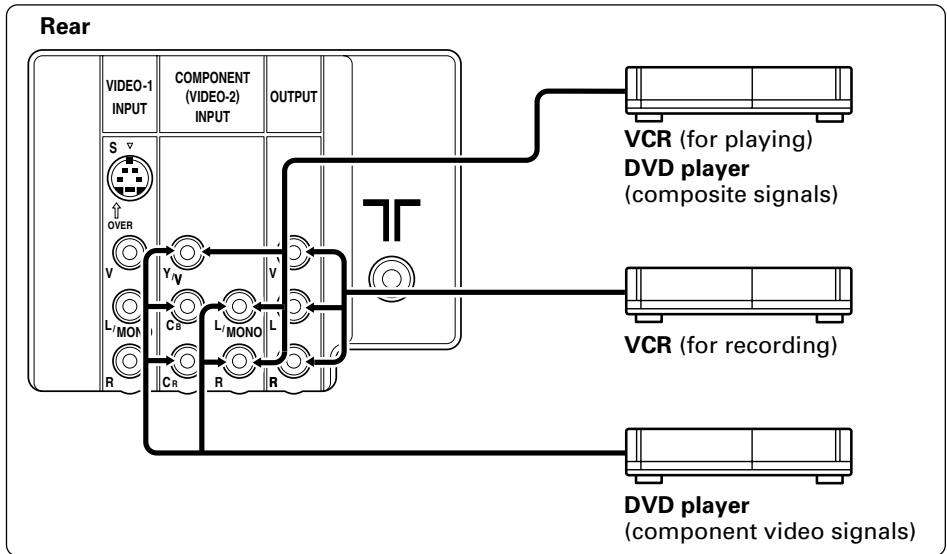
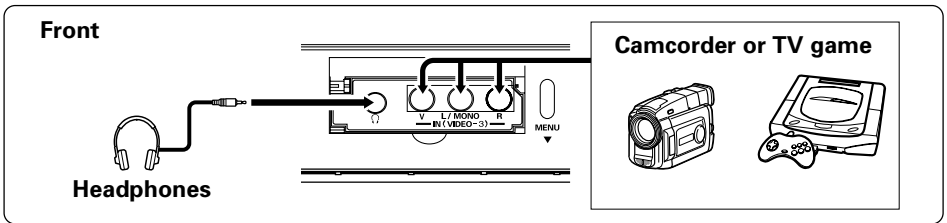

4 Connect the power cord to the AC outlet

Operate only from the power source indicated on the rear of the TV.

Preparation

5 SETUP TOUR

When the TV is first turned on it enters the SETUP TOUR mode, and the JVC logo is displayed. Follow the instructions on the on-screen display to perform the SETUP TOUR.

- In case of resetting that the reason for such as removal, you can set the AUTO CH PRESET function on the "MENU 3" menu. For details, see page 19.

1 Press the Main power button on the TV.

The POWER lamp lights. After the JVC logo has been displayed, the TV automatically switches to the language setting mode.



2 Press the CHANNEL +/- or the MENU </> buttons to select the on-screen language.

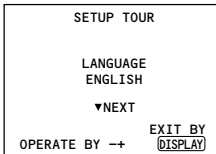

3 Press the CHANNEL +/- or the MENU </> buttons to select the teletext language group. For details, see page 21. (For AV-21WX11, AV-29WX11 and AV-21YX11 series will skip this step.)

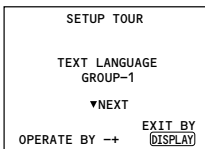

4 The AUTO PROGRAMMING function will start and the indicator blinks.

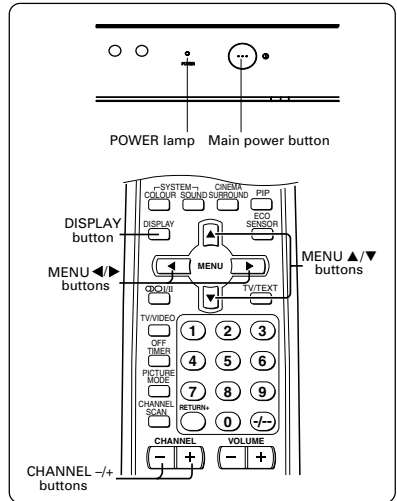
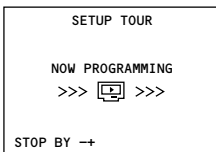

- To stop the AUTO PROGRAMMING function, press the CHANNEL +/- or the MENU </> buttons.

When all the TV channels that can be received on your TV have been preset, the display goes out and the AUTO PROGRAMMING function operation is completed.

- If a TV channel you want to view is not set to the channel, set it with the MANUAL CH PRESET function. For details, see page 20.

5 Upon the completion of AUTO PROGRAMMING function, the message below is displayed.

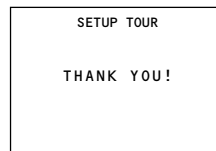

Basic operation

Your remote control may not look exactly like the illustration.

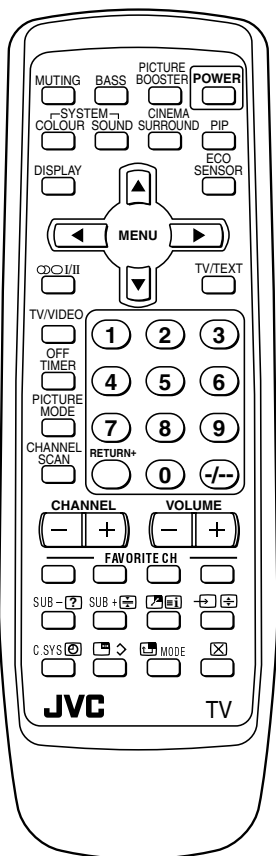

Note: For the function buttons available for your TV set, please refer to which Remote Control you have (See page 7 for details).

1 Press the **POWER** button to turn your **TV** on.

- If your TV does not turn on, press the Main power button on the TV then press the POWER button again.
- You can also turn on your TV by pressing any of the following buttons;
 - the CHANNEL $-/+$ button
 - the Number buttons
 - the TV/VIDEO button

2 Select a channel.

- Press the CHANNEL $-/+$ button.
 - Up/down selection cannot be selected for channels to which the SKIP has been set to "YES". See page 21.
- Press the Number buttons to enter the channel number.
 - If you want to enter a two-digit number, press the $-/--$ button to select the two digit mode "--", then enter the channel number.

3 Press the **VOLUME** $-/+$ button to adjust the sound.

4 To turn your TV off, press the **POWER** button.

- We recommend that you press the Main power button on the TV to turn the main power off if you do not plan to use your TV for a long time or if you wish to save energy.

If the picture is not clear:

Press the COLOUR SYSTEM button to select another colour system, see page 8.

If the sound is not clear:

Press the SOUND SYSTEM button to select another sound system, see page 8.











Viewing Images from an External Device:

Press the TV/VIDEO button to select the VIDEO mode.

- You can also use the INPUT function to select the VIDEO mode. For details, refer to page 16.

Remote control buttons and functions

Cross Reference table for TV set and Remote Control

TV set		AV-21VS21 AV-21WS21 AV-25VS21 AV-29VS21 AV-29WS21	AV-21VX71 AV-25VX71 AV-29VX71	AV-21WX11 AV-29WX11	AV-21YX11	Refer to page no.
REMOTE CONTROL		RM-C1301	RM-C1302	RM-C1306	RM-C1310	
MUTING		○	○	○	○	8
PICTURE BOOSTER		-	-	-	○	8
COLOUR SYSTEM		○	○	○	○	8
SOUND SYSTEM		○	○	○	○	8
CINEMA SURROUND		○	○	○	○	8
DISPLAY		○	○	○	○	9
ECO SENSOR		○	○	○	○	9
∞○/II		○	-	-	-	9
TV/VIDEO		○	○	○	○	6
OFF TIMER		○	○	○	○	9
PICTURE MODE		○	○	○	○	10
CHANNEL SCAN		○	○	○	○	10
FAVORITE CH		○	○	○	○	10
RETURN +		○	○	○	○	10
PIP	SUB +/-	-	○	-	-	11
	SWAP 	-	○	-	-	11
	INPUT 	-	○	-	-	11
	C.SYS	-	○	-	-	12
	FREEZE 	-	○	-	-	12
	POSITION 	-	○	-	-	12
TV/TEXT	REVEAL 	○	○	-	-	14
	HOLD 	○	○	-	-	14
	INDEX 	○	○	-	-	14
	SIZE 	○	○	-	-	14
	SUBPAGE 	○	○	-	-	14
	STORE 	○	○	-	-	14
	MODE	○	○	-	-	13
	CANCEL 	○	○	-	-	14

Remote control buttons and functions

MUTING button

You can turn the sound off instantly.

Press this button.

To turn the sound on, press this button again.

PICTURE BOOSTER button

When the picture is unclear because the reception level of the TV signal is low, activating the Picture Booster improves the picture clarity in some situations. Repeatedly press the PICTURE BOOSTER button to select the desired mode.

HIGH:

The Picture Booster is functioning at maximum.

LOW:

The Picture Booster is functioning at minimum.

OFF:

The Picture Booster is off.

- If the picture becomes abnormal when you set the Picture Booster to **HIGH**, then set it to **LOW** or **OFF**.

COLOUR SYSTEM button

If the picture is not clear or no colour appears, change the current colour system to another colour system.

Press this button to select the colour system.

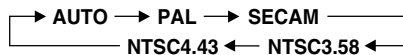

AUTO:

Automatic colour system selection.

- For the colour systems in each country or region, see the table “Broadcasting systems” on page 27.
- If the picture is not normal in the AUTO mode, change the AUTO mode to another colour system.

SOUND SYSTEM button

If the sound is not clear even when the picture appears normal, change the current sound system to another sound system.

Press this button to select the sound system.

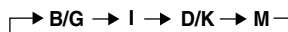

- For the sound systems in each country or region, see the table “Broadcasting systems” on page 27.
- You cannot select any sound system when in a VIDEO mode.

CINEMA SURROUND button

You can enjoy an enhanced sound for a wider audience by using CINEMA SURROUND function.

Press this button to select one of the CINEMA SURROUND mode.

HIGH/LOW:

When you listen to the stereo sound, please select HIGH mode or LOW mode. You can enjoy the sound for a wider audience similar to the experience at the theatre.

- In case that you setting up the CINEMA SURROUND function to HIGH mode, there may be slight volume distortion. In case that occurs, please switch the HIGH mode to LOW mode, the effect of CINEMA SURROUND functions will be less noticeable, however, the volume distortion will be corrected.

MONO SURROUND:

Select the MONO SURROUND mode, when you listen to the mono sound. You can enjoy the sound for a wider audience similar to stereo sound.

OFF:

The CINEMA SURROUND function switches off.

Remote control buttons and functions

DISPLAY button

You can continuously display the current channel number or VIDEO mode on the screen.

Press this button.

To turn the display off, press this button again.

- When selecting a VIDEO mode with no signal, indication of the VIDEO mode becomes fixed on the screen.

ECO SENSOR button

You can adjust this TV so that the screen automatically adjusts to the optimum contrast according to the brightness of your room. This function reduces eye strain and the power consumption of this TV.

Press this button to select the desired mode.

AI ECO SENSOR 1:

The AI ECO SENSOR function switches on.

Usually, it is recommended to watch the TV in this mode.

AI ECO SENSOR 2:

The AI ECO SENSOR function switches on.

If you feel the screen in the "AI ECO SENSOR 1" mode is too dark, select this mode.

AI ECO SENSOR OFF:

The AI ECO SENSOR function switches off.

- You can display on the screen the effect of the AI ECO SENSOR function.
For details, see "AI ECO DISPLAY" on page 23.

⊙⊙I/II button

< S series only >

You can select a sound setting for stereo broadcast programmes and bilingual programmes.

Press this button to select a sound setting.

- ⊙⊙ : Stereo sound
- I : Bilingual I (sub I) sound
- II : Bilingual II (sub II) sound
- ⊙ : Monaural sound

MONO: Cancels the multi-sound function, and the sound becomes monaural.

- If you have poor reception of a stereo broadcast, you can change from stereo sound (⊙⊙) to monaural sound (⊙) so that you can hear the broadcast more clearly and easily.
- If the multi-sound function cannot work normally due to poor signal quality, noise may be included in the sound, or the sound may change many times. If this happens, change the sound setting to MONO mode to cancel the multi-sound function.

OFF TIMER button

You can set the TV to automatically turn off after a set time.

Press this button to select the period of time.

- You can set the period of time to a maximum of 120 minutes in 10 minute increments.
- 1 minute before the OFF TIMER function turns off the TV, "GOOD NIGHT!" appears.

To display the remaining time, press this button once.

To cancel the OFF TIMER function, press this button to set the period of time to 0.

- The OFF TIMER function will not turn off the TV's main power.

Remote control buttons and functions

PICTURE MODE button

You can select one of three picture adjustment settings as you like.

Press this button to select a mode.

BRIGHT:

Heightens contrast and sharpness.

STANDARD:

Standardizes picture adjustments.

SOFT:

Softens contrast and sharpness.

- Pressing this button returns all the picture settings in "MENU 4" to their default settings.

CHANNEL SCAN button

You can quickly view all TV channels programmes that you can view on your TV, and search for the programme you want to view.

1 Press this button to start scanning TV channels.

The TV channel programmes are each displayed for several seconds.

- The programmes of TV channels for which the SKIP function is set to "YES" are not displayed.

2 When you find the programme you want to view, press this button again to stop scanning.

FAVORITE CH button

You can correlate 4 channels out of 99 channels (PR01-PR99) with FAVORITE CH buttons RED, GREEN, YELLOW and BLUE.

When not in TEXT mode, press one of the FAVORITE CH buttons for more than 3 seconds to correlate currently watching channel. After the channel and button are correlated, you can directly select favorite channel by the correlated button.

- When MENU is displayed, FAVORITE CH cannot be correlated.
- Correlation of FAVORITE CH button and the channel cannot be reset even though the main power is turned off.

RETURN + button

You can set a channel you frequently view to the Return Channel and you can view that channel at any time with one-touch.

To set the channel to the Return Channel:

- 1 Select the channel you want to set to the Return Channel.**
- 2 Press this button and hold until the message "RETURN PLUS PROGRAMMED!" appears.**

- When you turn off the TV, the Return Channel setting is canceled.

To view the Return Channel:

Press this button.

- You can view two channels (current channel and Return Channel) alternately by pressing this button.

To cancel the Return Channel setting:

Press this button and hold until the message "RETURN PLUS CANCELED!" appears.

If no channel is set to the Return Channel:

You can view the channel selected right before the current channel by pressing this button.

Remote control buttons and functions

PIP button

You can display sub-picture on top of main-picture.

Press this button to display sub-picture.

- When PIP button is pressed while sub-picture is displayed, sub-picture is closed.
- When TV/TEXT button is pressed while sub-picture is displayed, sub-picture is closed and TEXT screen is displayed.
- Only the sound for main-picture is audible using the headphone and the sound for sub-picture is not audible.
- When PIP button is pressed while the main-picture input source is the same as the last sub-picture input source, the input source of sub-picture is automatically changed to the next input source.
- When PIP button is pressed while BLUE BACK function is on and main-picture is not receiving TV signal, BLUE BACK function is disabled.
- When PIP button is pressed while MENU is displayed, MENU is closed and main-picture together with sub-picture on top are displayed.
- PIP button cannot operate in COMPRESS(16:9) mode.

SUB +/- button

When the input source of sub-picture is TV mode and sub-picture is displayed, you can change the channel of sub-picture by this button.

- When the input source of sub-picture is TV mode, pressing of SUB +/- button to effect up/down of channel.
- When the input source of sub-picture is other than TV mode, SUB +/- button is disabled.

SWAP () button

You can swap the input source of main and sub-pictures by this button while sub-picture is displayed.

Press this button to swap the input source of main and sub-pictures so that the image of sub-picture is displayed on main-picture and vice-versa.

INPUT () button

You can select the input source of sub-picture by this button.

Press this button repeatedly to select the desired input source.

- Depending on the input source of main-picture, each press of INPUT button changes the input source of sub-picture as follows:

Main-picture: TV mode

□ → VIDEO-1 → VIDEO-2 → VIDEO-3 □

Main-picture: VIDEO-1

□ → TV mode → VIDEO-2 → VIDEO-3 □

Main-picture: VIDEO-2

□ → TV mode → VIDEO-1 → VIDEO-3 □

Main-picture: VIDEO-3

□ → TV mode → VIDEO-1 → VIDEO-2 □

- When the input source of main-picture is set to VIDEO-2 with COMPONENT, PIP button is disabled and sub-picture cannot be displayed.
- When the input source of main-picture is other than VIDEO-2 and VIDEO-2 is set to COMPONENT, the input source of sub-picture cannot select VIDEO-2.

Remote control buttons and functions

C.SYS button

If the sub-picture is not clear or no colour appears, change the current colour system to another colour system.

- Press this button to select the colour system.



- About each selected mode, see “COLOUR SYSTEM button” on page 8.
- When the input of sub-picture is changed to VIDEO mode, the colour system of sub-picture is automatically set to AUTO mode.
- When the input of sub-picture is TV mode, the colour system of sub-picture depends on the colour system of each channel.

FREEZE () button

You can stop the motion of picture (FREEZE status) using this button.

- When FREEZE button is pressed while sub-picture is displayed, the motion of sub-picture is stopped (FREEZE status).
- When any available button is pressed during sub-picture is in FREEZE status, the motion of sub-picture returns to normal, otherwise, the sub-picture remains at FREEZE status.
- When sub-picture is not displayed, FREEZE button is disabled.

POSITION () button

You can move the position of sub-picture to either bottom left, top left, top right or bottom right by this button.

- When PIP is pressed, sub-picture is displayed at the last displayed position. Each press of POSITION button changes the displayed position of sub-picture.

Viewing teletext programmes

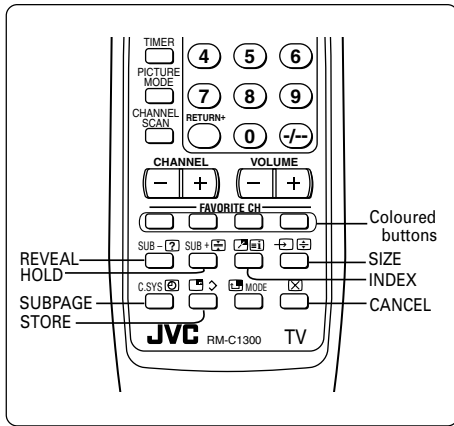

Basic operation

- 1 Select a TV channel with a teletext programme.
- 2 Press the TV/TEXT button to change the TV mode to the teletext mode.

The mode cycles as follows:

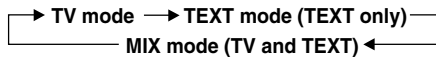

- 3 Select a teletext page by pressing the CHANNEL +/- button, Number buttons or coloured buttons.

To return to the TV mode, press the TV/VIDEO button or the TV/TEXT button.

- If you have trouble receiving teletext broadcasts, consult your local dealer or the teletext station.
- If characters on a teletext programme do not appear properly, change the TELETEXT LANGUAGE setting. For details, see "TEXT LANGUAGE" on page 21.

Using the List Mode

You can store the numbers of your favorite teletext pages in the List mode and call them up quickly using the coloured buttons.

To store the page numbers:

- 1 Press the MODE button to engage the List mode.
The stored page numbers are displayed at the bottom of the screen.
- 2 Press a coloured button to select a position. Then press the Number buttons to enter the page number.

- 3 Press and hold down the STORE button.

The four page numbers blink white to indicate that they are stored in memory.

To call up a stored page:

- 1 Press the MODE button to engage the List mode.
- 2 Press a coloured button to which a page has been assigned.

To exit the List mode, press the MODE button again.

Viewing teletext programmes

REVEAL (?)

Some teletext pages include hidden text (such as answers to a quiz). You can display the hidden text.

Each time you press the REVEAL button, text is hidden or revealed.

HOLD ()

You can hold a teletext page on the screen for as long as you want, even while several other teletext pages are being received.

Press the HOLD button.

To cancel the HOLD function, press the HOLD button again.

STORE ()

Press this to store the number of your favorite teletext pages in the List mode and call them up quickly using the coloured buttons.

CANCEL (X)

You can watch a TV programme even when in the teletext mode.

1 Press the Number button to enter a page number, or press a coloured button.

The TV starts searching for a teletext page.

2 Press the CANCEL button.

The TV programme appears.

When the TV finds the teletext page, its page number appears in the upper left of the screen.

3 Press the CANCEL button to view the teletext page.

- Pressing the CANCEL button cannot change the teletext mode to the TV mode.

INDEX (i)

You can return to the index page instantly.

Press the INDEX button.

In the List mode:

Returns to the page number displayed in the lower left area of the screen.

SUBPAGE ()

Some teletext pages include sub-pages that are automatically displayed. You can hold any sub-page, or view it at any time.

1 Press the SUBPAGE button to operate the Sub-page function.

2 Press the Number buttons to enter a sub-page number.

Example:

3rd sub-page → press 0, 0, 0 and 3.

- You can also select a sub-page by pressing the red or green button.

To cancel the Sub-page function, press the SUBPAGE button again.

SIZE (+)

You can double the height of the teletext display.

Press the SIZE button.

The teletext display changes cyclically.

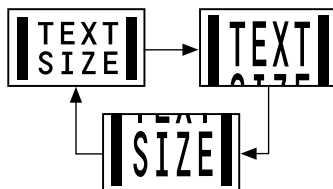

Using the TV's menus

This TV has a number of functions you can operate using the menus. To use all your TV's functions fully, you need to understand how to use the menu.

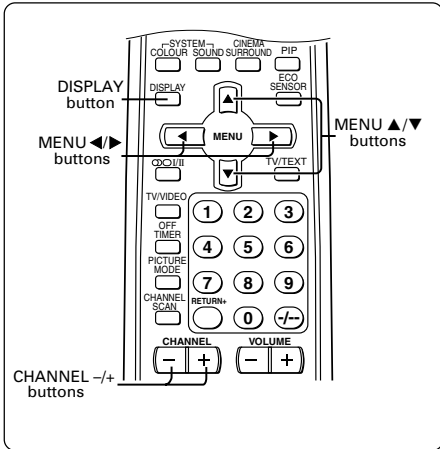

4 Press the CHANNEL +/- or the MENU ▲/▼ buttons to change function settings.

Example:

Changes the AUTO SHUTOFF setting.

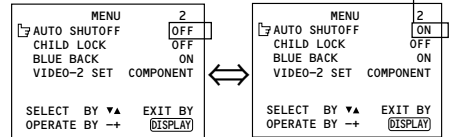

- With some functions, the operation method may differ.

5 Press the DISPLAY button to turn the display off.

- To operate a menu using the buttons on the front panel of the TV, refer to "Operating menus" on page 25.

Basic operation

1 Press the MENU ▲/▼ buttons. One of the 6 menus is displayed.

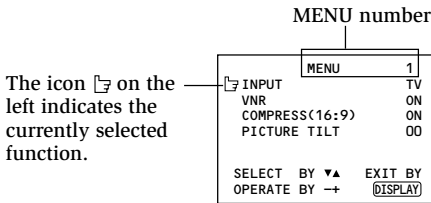

2 Repeatedly press the MENU ▲/▼ buttons to display a desired menu.

- If you hold down the ▼ button, the next menu is displayed.
- If the selected function is on the first line, pressing the ▲ button displays the preceding menu.

3 Repeatedly press the MENU ▲/▼ buttons to select a desired function.

Using the TV's menus

INPUT

You can view images from VCRs or other devices connected to your TV.

- 1 Press **MENU ▲/▼** to display the "MENU 1" menu, then select "INPUT".

MENU		1
INPUT	TV	ON
VNR	COMPRESS(16:9)	ON
PICTURE TILT		00

SELECT BY ▼▲ EXIT BY **DISPLAY**
OPERATE BY →←

- 2 Press **CHANNEL -/+** or **MENU ◀/▶** to select "VIDEO-1", "VIDEO-2" or "VIDEO-3".

TV mode changes to VIDEO mode.

PICTURE TILT

< AV-29VS21/AV-29WS21/AV-29VX71/
AV-29WX11 only >

There are cases where the Earth's magnetic force may make the picture tilt. If this happens, you can correct the picture tilt.

- 1 Press **MENU ▲/▼** to display the "MENU 1" menu, then select "PICTURE TILT".

MENU		1
INPUT	TV	ON
VNR	COMPRESS(16:9)	ON
PICTURE TILT		00

SELECT BY ▼▲ EXIT BY **DISPLAY**
OPERATE BY →←

- 2 Continue pressing **CHANNEL -/+** or **MENU ◀/▶** until the picture becomes level.

VNR

You can reduce picture noise.

- 1 Press **MENU ▲/▼** to display the "MENU 1" menu, then select "VNR".

MENU		1
INPUT	TV	ON
VNR	COMPRESS(16:9)	ON
PICTURE TILT		00

SELECT BY ▼▲ EXIT BY **DISPLAY**
OPERATE BY →←

- 2 Press **CHANNEL -/+** or **MENU ◀/▶** to select "ON".

To cancel the VNR function, select "OFF".

COMPRESS (16:9)

This function converts a normal picture (4:3 aspect ratio) into a wide picture (16:9 aspect ratio).

Use for pictures with a 16:9 aspect ratio that have been squeezed into a normal picture (4:3 aspect ratio), to restore their original dimensions.

- 1 Press **MENU ▲/▼** to display the "MENU 1" menu, then select "COMPRESS (16:9)".

MENU		1
INPUT	TV	ON
VNR	COMPRESS(16:9)	ON
PICTURE TILT		00

SELECT BY ▼▲ EXIT BY **DISPLAY**
OPERATE BY →←

- 2 Press **CHANNEL -/+** or **MENU ◀/▶** to select "ON".

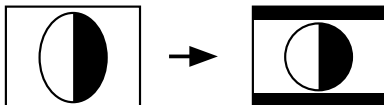

To cancel the COMPRESS (16:9) function, select "OFF".

- If COMPRESS (16:9) is changed to ON while sub-picture is displayed, the sub-picture will automatically be deleted.

Using the TV's menus

AUTO SHUTOFF

You can set your TV to turn off if no signals are received for about 15 minutes or longer after the end of a broadcast.

- 1 Press **MENU ▲/▼** to display the "MENU 2" menu, then select "AUTO SHUTOFF".

MENU	2
AUTO SHUTOFF	ON
CHILD LOCK	ON
BLUE BACK	ON
VIDEO-2 SET	COMPONENT
SELECT BY ▼▲ EXIT BY	
OPERATE BY → (DISPLAY)	

- 2 Press **CHANNEL -/+** or **MENU ◀/▶** to select "ON".

To cancel the AUTO SHUTOFF function, select "OFF".

- The AUTO SHUTOFF function does not turn off the TV's main power.
- The AUTO SHUTOFF will not work for a VIDEO mode.

CHILD LOCK

You can disable the front control buttons of the TV.

When this function is set to "ON", the TV can be operated using only the remote control.

Use this function to prevent children from operating the TV without parental consent.

- 1 Press **MENU ▲/▼** to display the "MENU 2" menu, then select "CHILD LOCK".

MENU	2
AUTO SHUTOFF	ON
CHILD LOCK	ON
BLUE BACK	ON
VIDEO-2 SET	COMPONENT
SELECT BY ▼▲ EXIT BY	
OPERATE BY → (DISPLAY)	

- 2 Press **CHANNEL -/+** or **MENU ◀/▶** to select "ON".

To cancel the CHILD LOCK function, select "OFF".

- The CHILD LOCK function is canceled when you turn the power off.

BLUE BACK

You can mute the sound and change the picture into a blue screen while no signals are received by the TV, or when the signals are unstable.

- 1 Press **MENU ▲/▼** to display the "MENU 2" menu, then select "BLUE BACK".

MENU	2
AUTO SHUTOFF	ON
CHILD LOCK	ON
BLUE BACK	ON
VIDEO-2 SET	COMPONENT
SELECT BY ▼▲ EXIT BY	
OPERATE BY → (DISPLAY)	

- 2 Press **CHANNEL -/+** or **MENU ◀/▶** to select "ON".

To cancel the BLUE BACK function, select "OFF".

- To view a broadcast even when the reception signal is poor, set the BLUE BACK function to "OFF".
- Even when the BLUE BACK function is set to "OFF", the sound may not be audible.

Using the TV's menus

VIDEO-2 SET

Set the VIDEO-2 SET correctly according to the video signal input from the external device connected to the VIDEO-2 terminal. If this setting is incorrect, images will not be displayed.

- 1 Press **MENU ▲/▼** to display the "MENU 2" menu, then select "VIDEO-2 SET".

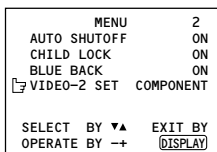

- 2 Set the VIDEO-2 SET according to the video signal input from the VIDEO-2 terminal.

If a normal video signal (composite video signal) is input:

Press the CHANNEL -/+ or the MENU ◀/▶ buttons to select "VIDEO".

If a component video signal (Y/C_B/C_R signals) is input:

Press the CHANNEL -/+ or the MENU ◀/▶ buttons to select "COMPONENT".

Picture Adjustments

You can adjust the picture as you like.

- 1 Press **MENU ▲/▼** to display the "MENU 4" menu.

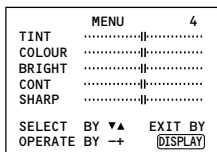

- 2 Press **MENU ▲/▼** to select an item and press CHANNEL -/+ or MENU ◀/▶ to adjust it.

TINT*	- : Reddish	+ : Greenish
COLOUR	- : Lighter	+ : Deeper
BRIGHT	- : Darker	+ : Brighter
CONT	- : Lower	+ : Higher
SHARP	- : Softer	+ : Sharper

* TINT (tint) is displayed only when viewing images from NTSC3.58 or NTSC4.43 colour systems.

Sound Adjustments

You can adjust the sound as you like.

- 1 Press **MENU ▲/▼** to display the "MENU 5" menu.

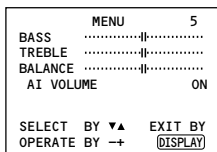

- 2 Press **MENU ▲/▼** to select an item and press CHANNEL -/+ or MENU ◀/▶ to adjust it.

BASS	- : Weaker	+ : Stronger
TREBLE	- : Weaker	+ : Stronger
BALANCE	- : Left	+ : Right

Using the TV's menus

AI VOLUME

You can prevent the sudden increase or decrease of volume that occurs when changing channels or switching VIDEO modes.

- 1 Press **MENU** ▲/▼ to display the "MENU 5" menu, then select "AI VOLUME".

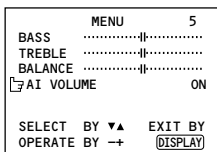

- 2 Press **CHANNEL** -/+ or **MENU** ◀/▶ to select "ON".

To cancel the AI VOLUME function, select "OFF".

- The AI VOLUME function may not operate as expected if the sound input level from a broadcast station (or video software) is extremely low.
- The AI VOLUME function for TV mode and VIDEO mode can be set separately. For example, you can set it to be off in TV mode and on in VIDEO mode. If you set the AI VOLUME function while viewing a TV channel, the setting is registered as the setting for TV mode. If you set the AI VOLUME function while viewing images from a VIDEO terminal, the setting is registered as the setting for VIDEO mode.

AUTO CH PRESET

You can automatically preset all TV channels that can be received by your TV to channels.

- 1 Press **MENU** ▲/▼ to display the "MENU 3" menu, then select "AUTO CH PRESET".

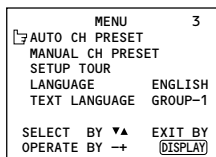

- 2 Press **CHANNEL** -/+ or **MENU** ◀/▶ to start the AUTO CH PRESET function.

">>> ON SEARCH" is displayed on the screen.

When all the TV channels that can be received on your TV have been preset, the display goes out and the AUTO CH PRESET function operation is completed.

To stop the AUTO CH PRESET:

Press the **CHANNEL** -/+ or the **MENU** ◀/▶ buttons.

- The AUTO CH PRESET function does not preset a TV channel to the AV channel (channel number 0).
- If the TV cannot preset the TV channel you want to view, preset it manually. For details, see "MANUAL CH PRESET" on page 20.

Using the TV's menus

MANUAL CH PRESET

You can manually preset desired TV channels to desired channels.

- 1 Press **MENU ▲/▼** to display the “MENU 3” menu, then select “MANUAL CH PRESET”.

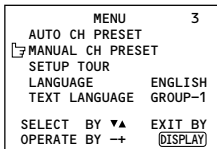

- 2 Press **MENU ◀/▶**.

The sub-menu is displayed.

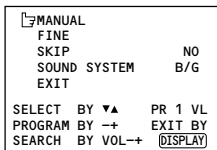

- The channel number is displayed as a PR number. For example, channel 1 will be displayed as PR 1. However, the AV channel will be displayed as AV.

- 3 Press **CHANNEL -/+** to select the channel number.

- 4 Press **VOLUME -/+** to start searching for the TV channel.

“>>>” or “<<<” is displayed on the screen.

When the TV finds a TV channel, the “>>>” or “<<<” display goes out, and the TV channel is preset to the currently selected channel number.

- If the TV channel you want to preset is not displayed, repeat step 4 until the TV finds the TV channel you want to preset.
- To stop the MANUAL CH PRESET function, press any button other than the VOLUME -/+ button.

If the picture is not clear:
Fine-tune the TV channel.

- 1 Press **MENU ▲/▼** to select “FINE”.

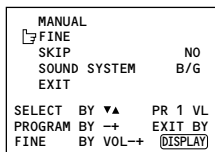

- 2 Hold **VOLUME -/+** down to fine-tune the TV channel so that the best image is displayed on screen.

“>” or “<” indicates that the TV is fine-tuning the TV channel.

If the sound is not clear:

- 1 Press **MENU ▲/▼** to select “SOUND SYSTEM”.

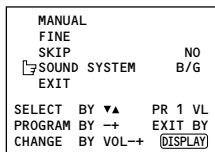

- 2 Press **VOLUME -/+** to select the appropriate sound system.

- For the sound systems in each country or region, refer to the table “Broadcasting systems” on page 27.

- 5 Press **MENU ▲/▼** to select “MANUAL”.

- 6 Repeat steps 3 to 5 if you want to preset another TV channel to a channel.

Using the TV's menus

SKIP

You can set undesired channels to be skipped. Channels set to be skipped cannot be selected by the CHANNEL +/- buttons nor the CHANNEL SCAN button.

- Channels to which TV channels have not been preset are automatically set to be skipped.

1 Press MENU ▲/▼ to display the "MENU 3" menu, then select "MANUAL CH PRESET".

2 Press MENU ◀/▶.

The sub-menu is displayed.

3 Press MENU ▲/▼ to select "SKIP".

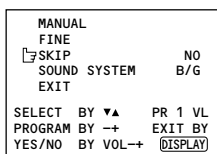

4 Press CHANNEL +/- to select the channel you want to skip.

5 Press VOLUME +/- to select "YES".
The channel is set to be skipped.
To cancel the SKIP function, select "NO".

6 Repeat steps 4 and 5 if you want to set another channel to skip.

LANGUAGE

You can select the language for the on-screen display.

1 Press MENU ▲/▼ to display the "MENU 3" menu, then select "LANGUAGE".

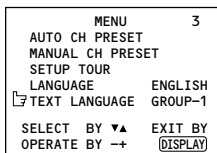

2 Press CHANNEL +/- or MENU ◀/▶ to select language.

The on-screen display indications are in the selected language.

TEXT LANGUAGE

You can select one of 5 teletext language groups. Set the teletext language group that corresponds to the language of the teletext programme that you want to watch.

1 Press MENU ▲/▼ to display the "MENU 3" menu, then select "TEXT LANGUAGE".

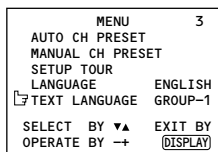

2 Press CHANNEL +/- or MENU ◀/▶ to select a group.

Group	languages
GROUP-1	English, German, Swedish / Finnish / Danish / Hungarian, Italian, French, Spanish / Portuguese, Turkish
GROUP-2	Polish, German, Estonian, Slovenian, Czech / Slovakian, Rumanian
GROUP-3	Polish, German, Estonian, Lettish, Russian, Ukrainian
GROUP-4	English, French, Turkish, Arabic
GROUP-5	English, French, Turkish, Farsi

- Depending on the broadcast, the language set may not display properly.

Using the TV's menus

FAVORITE CH SETTING

You can set PICTURE MODE, VNR and PICTURE EFFECT functions for the favorite channels using FAVORITE CH SETTING menu.

- 1 Press MENU ▲/▼ to display the "MENU 6" menu, then select "FAVORITE CH SETTING".

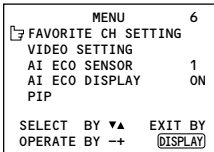

- 2 Press MENU ◀/▶.

The sub-menu is displayed.

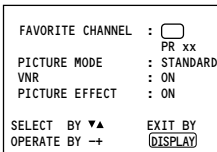

- 3 Press CHANNEL -/+ to select one of the colours "RED", "GREEN", "YELLOW" or "BLUE" assigned to FAVORITE CH button.
- 4 Press MENU ▲/▼ to select "PICTURE MODE", then press CHANNEL -/+ to select the picture mode of "BRIGHT", "STANDARD" or "SOFT".
- 5 Press MENU ▲/▼ to select "VNR", then press CHANNEL -/+ to select VNR "ON" or "OFF".
- 6 Press MENU ▲/▼ to select "PICTURE EFFECT", then press CHANNEL -/+ to select PICTURE EFFECT "ON" or "OFF".
 - PICTURE MODE and VNR settings are changed only when you press the FAVORITE CH button while PICTURE EFFECT is ON. Otherwise, PICTURE MODE and VNR are not changed.

VIDEO SETTING

You can set PICTURE MODE, VNR and PICTURE EFFECT functions for VIDEO mode using VIDEO SETTING menu.

- 1 Press MENU ▲/▼ to display the "MENU 6" menu, then select "VIDEO SETTING".

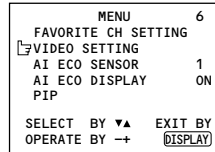

- 2 Press MENU ◀/▶.

The sub-menu is displayed.

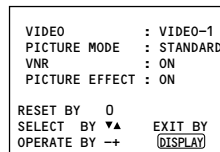

- 3 Press CHANNEL -/+ to select "VIDEO-1", "VIDEO-2" or "VIDEO-3".
- 4 Press MENU ▲/▼ to select "PICTURE MODE", then press CHANNEL -/+ to select the picture mode of "BRIGHT", "STANDARD" or "SOFT".
- 5 Press MENU ▲/▼ to select "VNR", then press CHANNEL -/+ to select VNR "ON" or "OFF".
- 6 Press MENU ▲/▼ to select "PICTURE EFFECT", then press CHANNEL -/+ to select PICTURE EFFECT "ON" or "OFF".
 - PICTURE MODE and VNR settings are changed only when VIDEO input mode is selected while PICTURE EFFECT is ON. Otherwise, PICTURE MODE and VNR are not changed.
 - Press 0 button to reset the setting.

Using the TV's menus

AI ECO SENSOR

You can enable this function so that the brightness of TV screen is automatically adjusted according to the brightness of your room.

- 1 Press **MENU ▲/▼** to display the "MENU 6" menu, then select "AI ECO SENSOR".

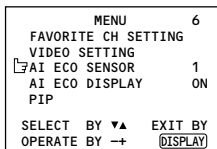

- 2 Press **CHANNEL -/+** or **MENU ◀/▶** to select "OFF", "1" or "2".

- For detailed description, see the "ECO SENSOR button" on page 9.

AI ECO DISPLAY

You can display on the screen the effect of the AI ECO SENSOR function.

- 1 Press **MENU ▲/▼** to display the "MENU 6" menu, then select "AI ECO DISPLAY".

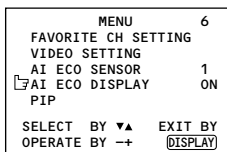

- 2 Press **CHANNEL -/+** or **MENU ◀/▶** to select "ON".

The clover mark indicating the brightness of your room is displayed for several seconds each time the brightness changes. The number of clover marks displayed on screen increases as your room becomes darker. To cancel the AI ECO DISPLAY function, select "OFF".

- To switch the AI ECO SENSOR'S mode, see the "ECO SENSOR button" on page 9.

PIP

This function is the same as the function of PIP buttons. For details, refer to page 11 and 12.

- 1 Press **MENU ▲/▼** to display the "MENU 6" menu, then select "PIP".

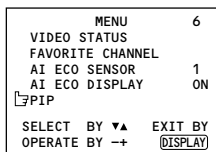

- 2 Press **MENU ◀/▶**.
The sub-menu is displayed.

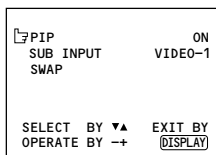

- 3 Press **CHANNEL -/+** to select PIP "ON" or "OFF".
- 4 Press **MENU ▲/▼** to select "SUB INPUT", then press **CHANNEL -/+** to select "TV mode", "VIDEO-1", "VIDEO-2" or "VIDEO-3".
- 5 Press **MENU ▲/▼** to select "SWAP", then press **CHANNEL -/+** to select main or sub-picture.

TV buttons and parts

< AV-29VS21/AV-29WS21/AV-29VX71/AV-29WX11 >

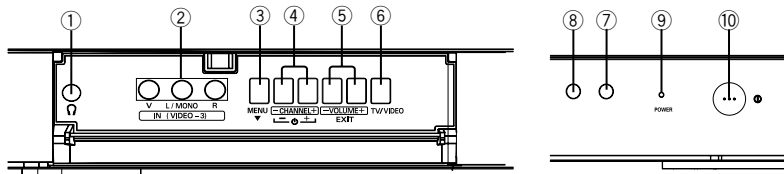

< AV-21YX71 >

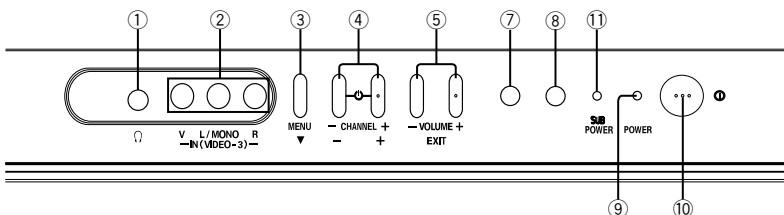

< AV-21VS21/AV-21VX71/AV-25VS21/AV-25VX71 >

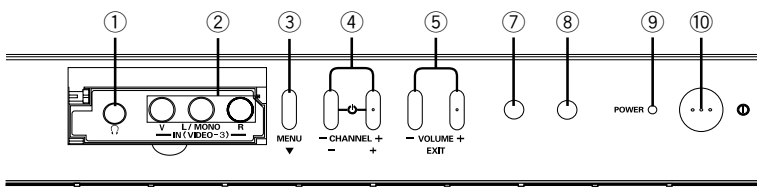

< AV-21WS21/AV-21WX11 >

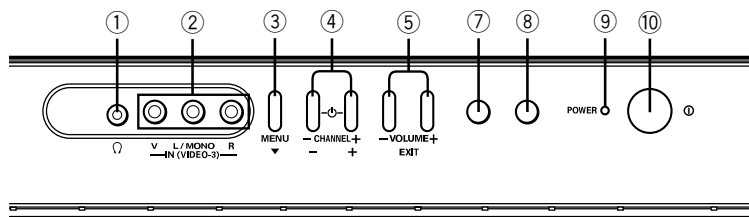

- ① Headphone jack
- ② VIDEO-3 terminal
- ③ MENU button
- ④ CHANNEL -/+ buttons
- ⑤ VOLUME -/+ buttons
- ⑥ TV/VIDEO button
- ⑦ ECO sensor
- ⑧ Remote control sensor

- ⑨ POWER lamp
- ⑩ Main power button
- ⑪ SUB POWER lamp

< AV-21YX71 only >

When the main power is switched on, the POWER lamp turns red.

When the TV is turned on (the sub power is on), the SUB POWER lamp turns green.

Using the buttons on the TV

Basic operation

Check to make sure the CHILD LOCK function is set to "OFF". When the CHILD LOCK function is set to "ON", the TV cannot be operated using the front control buttons. For details, see "CHILD LOCK" on page 17.

- 1 Press CHANNEL $-/+$ to turn the TV on from standby mode.
- 2 Press CHANNEL $-/+$ to select a channel.
- 3 Press VOLUME $-/+$ to adjust the volume.
- 4 To turn your TV off, press the Main power button to turn off the TV's main power.

To change the TV mode to the VIDEO mode:

- Press the TV/VIDEO button if the TV has one. See page 6.
- If the TV has no TV/VIDEO button, select the VIDEO mode with the INPUT function in "MENU 1".

Operating menus

You can operate function in menus using the front control buttons on the TV.

- 1 Press MENU \blacktriangledown to display a menu.
- 2 Press MENU \blacktriangledown repeatedly to display the menu you want to use.
- 3 Press MENU \blacktriangledown to select the desired function or item.
- 4 Press CHANNEL $-/+$ or VOLUME $-/+$ to carry out the desired operation.
For details, see the description for each function.
- 5 Press VOLUME $-/+$ to turn the menu display off.

To turn the sub-menu display off:

- 1 Press MENU \blacktriangledown to select "EXIT".

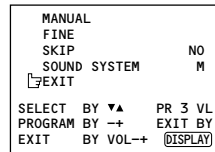

- 2 Press VOLUME $-/+$ to turn the display off.

Troubleshooting

If there is no picture or the TV does not operate normally, make sure the problem isn't due to the reasons indicated below.

If the problem persists even after taking the measures indicated, please contact a service technician.

Cannot turn the TV on

- Press the Main power button on the TV.
- Connect the power cord to the AC outlet.

The screen turns blue

- Is the BLUE BACK function on? (see page 17.)

Remote control inoperable

- Replace the batteries. (see page 2.)

Buttons on front of the TV do not work

- Switch the CHILD LOCK function off. (see page 17.)

TV does not respond immediately

- Press the main power button on the TV to turn off the main power. Press the main power button again to turn on the TV. If the TV returns to a normal state, operation is normal.

The TV turns off suddenly

- Is the OFF TIMER function set to operate? (see page 9.)
- Is the AUTO SHUTOFF function on? (see page 17.)

Poor sound

- Press the SOUND SYSTEM button to select another sound system. (see page 8.)
- Adjust the sound settings. (see page 18.)

Poor picture

- Press the COLOUR SYSTEM button to select another colour system. (see page 8.)
- Adjust the picture settings. (see page 18.)
- Is a component signal output device, such as a DVD player, connected correctly? (see page 4.)
- Is the VIDEO-2 SET function setting correct? (see page 18.)
- If noise (snow) totally blocks out the picture, check the following.
 - Have the TV and aerial been connected properly?
 - Has the aerial cable been damaged?
 - Is the aerial pointing in the right direction?
 - Is the aerial itself faulty?
- If the TV or aerial suffer interference from other equipment, stripes or noise may appear in the picture. Move any equipment which can cause interference away from the TV.
- If the TV or aerial suffer interference from signals reflecting from mountains or buildings, double-pictures (ghosting) will occur. Change the aerial's direction or replace it with an aerial with better directionality.
- When a white and bright still image (such as a white dress) is displayed on the screen, the white part may look as if it is coloured. When the image disappears from the screen, the unnatural colours will also disappear.

The picture is tilted

< AV-29VS21/AV-29WS21/AV-29VX71/
AV-29WX11 only >

- A picture may be tilted due to the influence of the earth's magnetism. In this case, use the PICTURE TILT function to adjust the tilt. (see page 16.)

Specifications

TV RF systems

B, G, I, D, K, M

Colour systems

PAL, SECAM, NTSC 3.58 MHz, NTSC 4.43 MHz

Receiving channels

VHF low channel (VL), VHF high channel (VH), UHF channel (U)
Receives cable channels in mid band, super band and hyper band.

External input / output

VIDEO-1: S-video input, VIDEO input, AUDIO L/R input
VIDEO-2/COMPONENT: VIDEO input, AUDIO L/R input,
COMPONENT VIDEO (Y/Cb/Cr) input
VIDEO-3: VIDEO input, AUDIO L/R input
OUTPUT: VIDEO output, AUDIO L/R output
Headphone jack: stereo mini jack (3.5 mm diameter)

Teletext system (AV-21VS21/AV-21WS21/AV-21VX71/ AV-25VS21/AV-25VX71/AV-29VS21/ AV-29WS21/AV-29VX71 only)

FLOF (Fasttext),WST (World Standard Text)

Language displayed by teletext (AV-21VS21/AV-21WS21/AV-21VX71/ AV-25VS21/AV-25VX71/ AV-29VS21/AV-29WS21/AV-29VX71 only)

Please see the table in the description "TEXT LANGUAGE" on page 21.

Design and specifications subject to change without notice.

Broadcasting systems

Area	Country or Region	System	
		Colour	Sound
Asia, Middle East	Bahrain, Kuwait, Oman, Qatar, United Arab Emirates, Yemen, etc. Indonesia, Malaysia, Singapore, Thailand, India, etc.	PAL	B/G
	China, Vietnam, etc.	PAL	D/K
	Hong Kong, etc.	PAL	I
	Islamic Republic of Iran, Lebanon, Saudi Arabia, etc.	SECAM	B/G
	Philippines, Taiwan, Myanmar, etc.	NTSC	M
Europe	Russia, etc.	SECAM	D/K
	Czech Republic, Poland, etc.	PAL	D/K
	Germany, Holland, Belgium, etc.	PAL	B/G
	UK, etc.	PAL	I
Oceania	Australia, New Zealand, etc.	PAL	B/G
Africa	Republic of South Africa, etc.	PAL	I
	Nigeria, etc.	PAL	B/G
	Egypt, Morocco, etc.	SECAM	B/G

JVC
VICTOR COMPANY OF JAPAN, LIMITED